

ADATTE PER LAVORI DOVE SONO RICHIESTI PRECISIONE,
AFFIDABILITÀ, REPERIBILITÀ E BLOCCAGGIO SICURO. INDICATA PER
LAVORI...

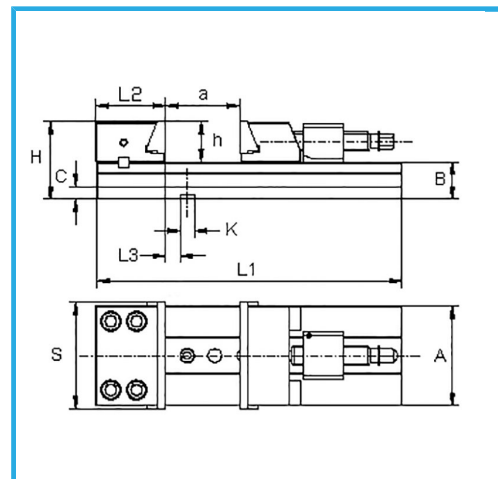

€1.670,00

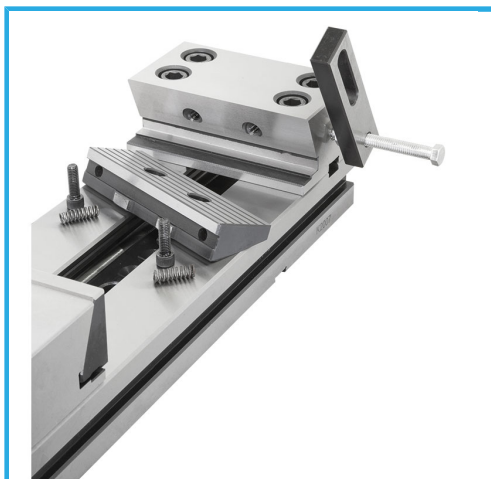
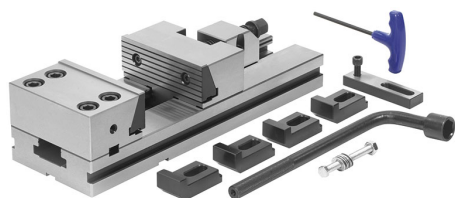

Dimensioni ganascia

S	150 mm
A	150 mm
B	50 mm
C	20 mm
H	110 mm
L1	525 mm
L2	93 mm
L3	25,6 mm
h	60 mm
K h7	16 mm
a	300 mm

Peso netto 35 kg

Dimensioni imballo 570x200x190 h mm

Peso lordo 40,00 kg

Codice EAN 8012667191429



Cassa di
legno



Temprato



Acciaio



Rettificato