

ADATTE PER LAVORI DOVE SONO RICHIESTI PRECISIONE, AFFIDABILITÀ, REPERIBILITÀ E BLOCCAGGIO SICURO. INDICATA PER LAVORI...

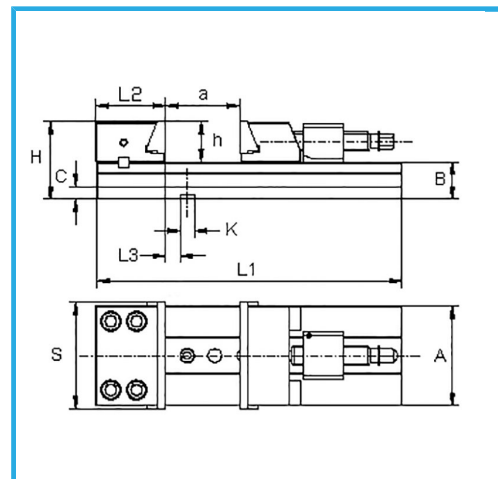

€1.160,00

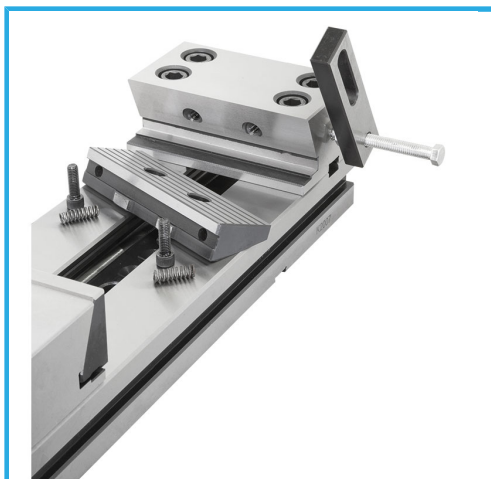
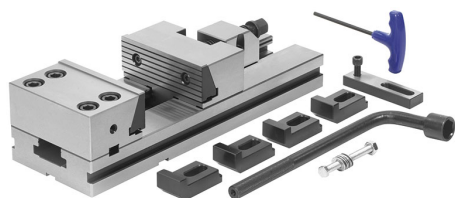

Dimensioni ganascia

S	125 mm
A	125 mm
B	40 mm
C	15 mm
H	90 mm
L1	350 mm
L2	80 mm
L3	25,6 mm
h	50 mm
K h7	16 mm
a	150 mm

Peso netto 19 kg

Dimensioni imballo 445x185x140 h mm

Peso lordo 20,10 kg

Codice EAN 8012667201173



Cassa di legno



Temprato



Acciaio



Rettificato