

## **UTENSILI PROFESSIONALI**

PROFESSIONAL TOOLS  
OUTILS PROFESSIONNELS  
KAROSSERIE-RICHTWERKZEUG

Made in Italy 

### ART. 251 PINZA AUTOBLOCCANTE AUTOMATICA

Fast automatic clamp  
Pince autobloquante automatique  
Zugklemme, selbstspannend (automatisch)

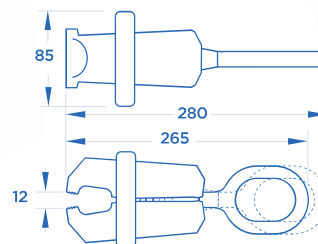

### ART. 276 PINZA AUTOBLOCCANTE AUTOMATICA A TENAGLIA

Fast selflocking scissor clamp  
Pince à tenailles autobloquante automatique  
Zangenzugklemme, selbstspannend

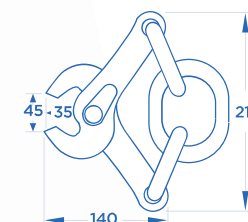

### ART. 277 PINZA AUTOBLOCCANTE A TIRAGGIO PLURIDIREZIONALE

Selflocking swivel clamp  
Pince autobloquante pluridirectionelle  
Zugklemme, selbstspannend, mit beweglicher Zugöse

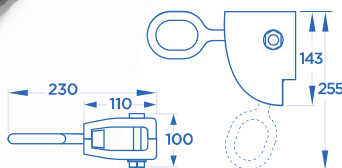

### ART. 277/A MINI PINZA AUTOBLOCCANTE A TIRAGGIO PLURIDIREZIONALE

Mini selflocking swivel clamp  
Mini pince autobloquante à traction pluridirectionnelle  
Kleine Zugklemme, selbstspannend

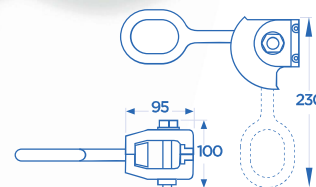

### ART. 278 PIASTRA PLURIFORATA PER TRAZIONE TELAIO

Multi-drilled pull plate  
Barre de traction à perforations  
Zugbügel mit verschiedenen Befestigungslöcher

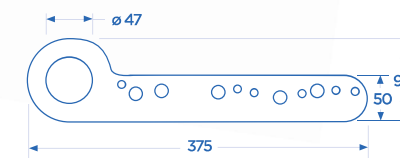

**ART. 279 • 279/A**  
**MORSETTO AUTOSERRANTE**  
**DI TRAZIONE (MM. 100)**

Selflocking clamp width (100 mm.)  
Pince de traction (100 mm.)  
Zugklemme, selbstspannend (100 mm.)

ART. 279/A

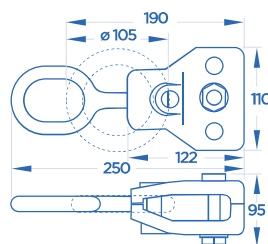

ART. 279

**ART. 280 • 280/A**  
**MORSETTO AUTOSERRANTE**  
**PER AGGOCCIOLATOI (MM. 70)**

Selflocking clamp width (70 mm.)  
Pince de traction (70 mm.)  
Zugklemme, selbstspannend (70 mm.)  
für Regenrinne

ART. 280/A

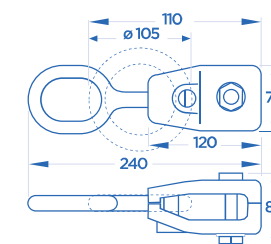

ART. 280

**ART. 281 • 281/A**  
**MORSETTO AUTOSERRANTE**  
**DI TRAZIONE (MM. 45)**

Selflocking clamp width (45 mm.)  
Pince de traction (45 mm.)  
Zugklemme, selbstspannend (45 mm.)

ART. 281/A

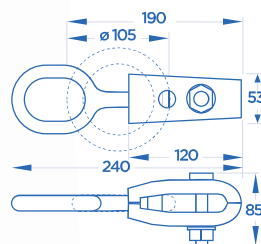

ART. 281

**ART. 282 • 282/A**  
**MORSETTO AUTOSERRANTE**  
**DI TRAZIONE A ANGOLO RETTO**

Selflocking right angle clamp  
Pince de traction à angle droit  
Zugklemme, selbstspannend,  
mit zwei Zugmöglichkeiten

ART. 282/A

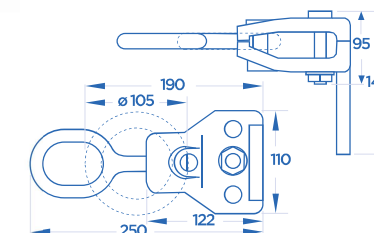

ART. 282

**ART. 285**  
**BRACCIO A GANCIO CON TRE ATTACCHI**  
**ADATTABILI, DI CUI UNO FILETTATO**

Arm with 3 adjustable couplings of which one is threaded  
Crampon avec trois attaches dont une filetée  
Zugbügel mit drei anpaßbaren Befestigungsstücken

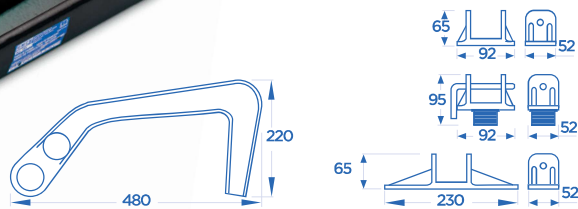

**ART. 297**  
**MORSETTO PICCOLO**

Little clamp  
Petit étau  
Kleine Klemme (mit Ring)

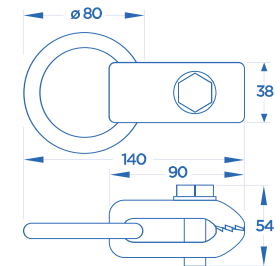

**ART. 299/M**  
**MORSETTO A TENAGLIA**

Pincer clamp  
Étau à tenaille  
Zangenklemme

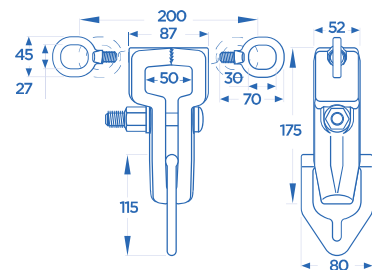

**ART. 299/N**  
**MORSETTO A TENAGLIA**

Pincer clamp  
Étau à tenaille  
Zangenklemme

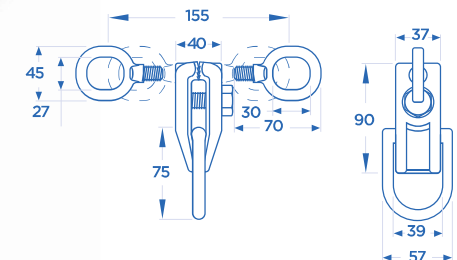

**ART. 299/O**  
**STAFFATORE PER CINGHIE E CATENE**

Molder for belts and chains  
Guide pour chaînes et sangles  
à double traction  
Bügel für Riemen und Ketten

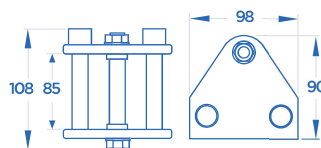

**ART. 393**  
**MORSETTO A DOPPIO BRACCIO MULTIUSO**

Multipurpose double arm clamp  
Étau à double bras multifonctionnel  
Zugklemme mit vielseitig verwendbarem Doppelarm

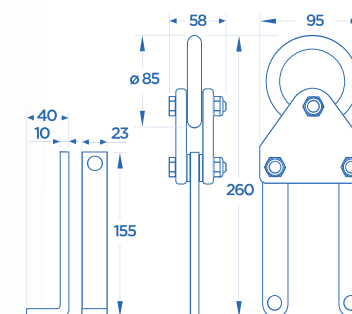

**ART. 295/SP**  
**MORSETTO AUTOBLOCCANTE AUTOMATICO CON GANASCE RIPORTATE (MM. 60)**

Automatic selflocking clamp with inserted jaws (mm. 60)  
Étau autobloquant automatique avec mâchoires (mm. 60)  
Automatisch selbstspannende Zugklemme mit auswechselbaren Backen (60 mm.)

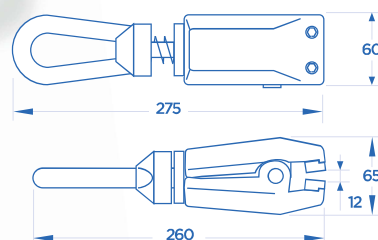

**ART. 296/SP**  
**MORSETTO AUTOBLOCCANTE AUTOMATICO CON GANASCE RIPORTATE (MM. 100)**

Automatic selflocking clamp with inserted jaws (mm. 100)  
Étau autobloquant automatique avec mâchoires (mm. 100)  
Automatisch selbstspannende Zugklemme mit auswechselbaren Backen (100 mm.)

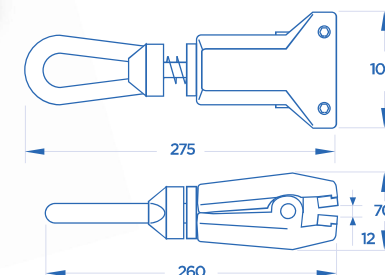



ART.

mm

RIF. A 800

RIF. B 1200

RIF. C 1800

RIF. D 1000



Cinghie in poliestere ad elevata resistenza. Particolarmente indicate per operazioni di tiro in carrozzeria, ben si adattano a molteplici e svariati impieghi. L'estrema flessibilità, duttilità e leggerezza, unite alla elevata capacità ed alla sicurezza d'impiego, ne fanno un indispensabile strumento di lavoro. Le asole terminali rinforzate ben si accoppiano con ganci e catene di nostra produzione.

High resistance belts in polyester. Particularly suited for pulling operations in car's body-work, and adapted for multiple and various uses. The extreme flexibility and lightness together with the high capacity and use safety, make it an indispensable work instrument. The straightened terminal holes fit well with hooks and chains produced by us.

Courroie en polyester à haute résistance. Par ses emplois variés et multiples, elle est particulièrement indiquée dans les opérations de tirage en carrosserie. Son extrême flexibilité, sa légèreté s'unissent à une capacité de tension élevée et à une sécurité d'emploi pour en faire un indispensable instrument de travail. Les boutonnières terminales renforcées s'adaptent aux crochets et chaînes de notre production.

Hochwiderstandsfähige Gurte aus Polyester. Geeignet für eine Vielzahl von Verwendungsmöglichkeiten, insbesondere für Karosserie-Zugarbeiten. Extreme Flexibilität, leichtes Gewicht sowie hohe Belastbarkeit und Sicherheit in der Anwendung machen sie zu einem unentbehrlichen Arbeitsgerät. Die Klemmenaufnahmen der Gurte passen für alle von OMCN hergestellten Haken und Ketten.

## CATENE E GANCI IN ACCIAIO LEGATO AD ELEVATA RESISTENZA, BONIFICATE, COLLAUDATE, CROMATE

CHROMED, TESTED AND TEMPERED CHAINS AND HOOKS IN HIGH RESISTANCE ALLOY STEEL

CHAÎNES ET CROCHETS EN ACIER ALLIÉ HAUTE RESISTANCE, TREMPÉES, TESTÉES, CHROMÉES

VERCHROMTE, GEHÄRTETE UND GEPRÜFTE KETTEN UND HAKEN AUS HOCHFESTER STAHLLEGIERUNG



## CAVO SICURO

Safety cable  
Câble de sûreté  
Sicherheitskabel

ART.	mm
325	1500
325/A	2000
325/B	2500
325/C	3000



## CON 1 GANCIO

with 1 hook  
1 crochet  
mit 1 Haken

ART.	mm
300	1500
301	2000
302	2500
303	3000



## CON 2 GANCI

with 2 hooks  
2 crochets  
mit 2 Haken

ART.	mm
304	1500
305	2000
306	2500
307	3000



**ART. 318**  
**DOPPIO GANCIO PER**  
**AGGANCIAMENTO**  
**E ASSEMBLAGGIO CATENE**

Twin hook to assemble chains  
 Deux crochets simples pour l'assemblage de deux chaînes  
 Doppelhaken zur Kettenverbindung



**ART. 316**  
**GANCIO CON ATTACCO**  
**A FORCELLA**

Hook with fork coupling  
 Crochet simple avec axe à goupille en acier  
 Haken



**ART. 323**  
**ACCORCIATORE**  
**E CONGIUNTORE DI CATENA**

Chain joiner and shortner  
 Double oeillet pour attache rapide de deux chaînes  
 Kettenverkürzer und Verbindungsglied